

寸法標準平尺

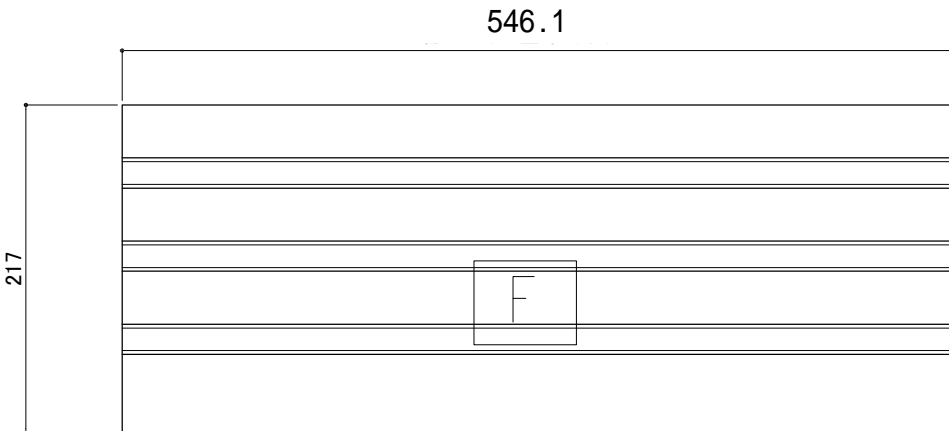
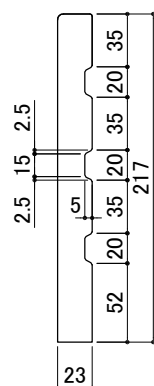
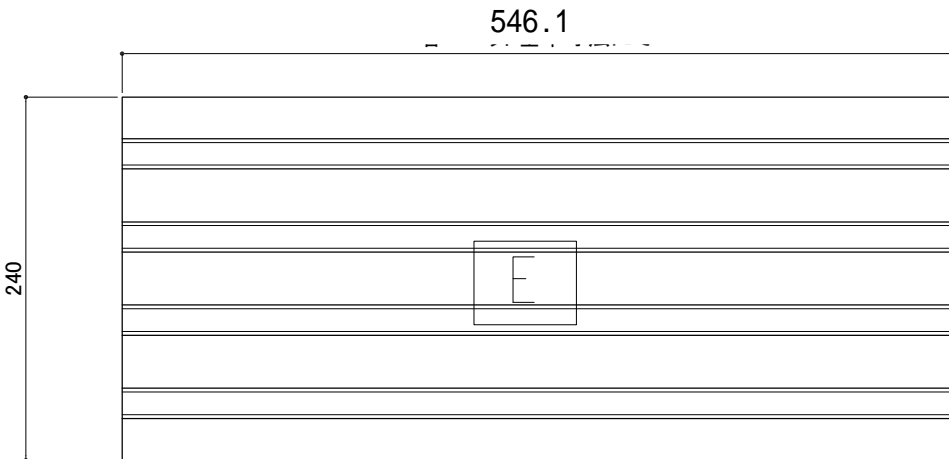
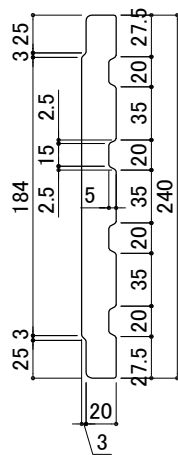
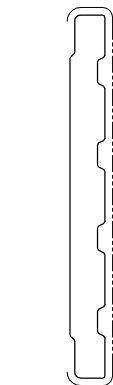
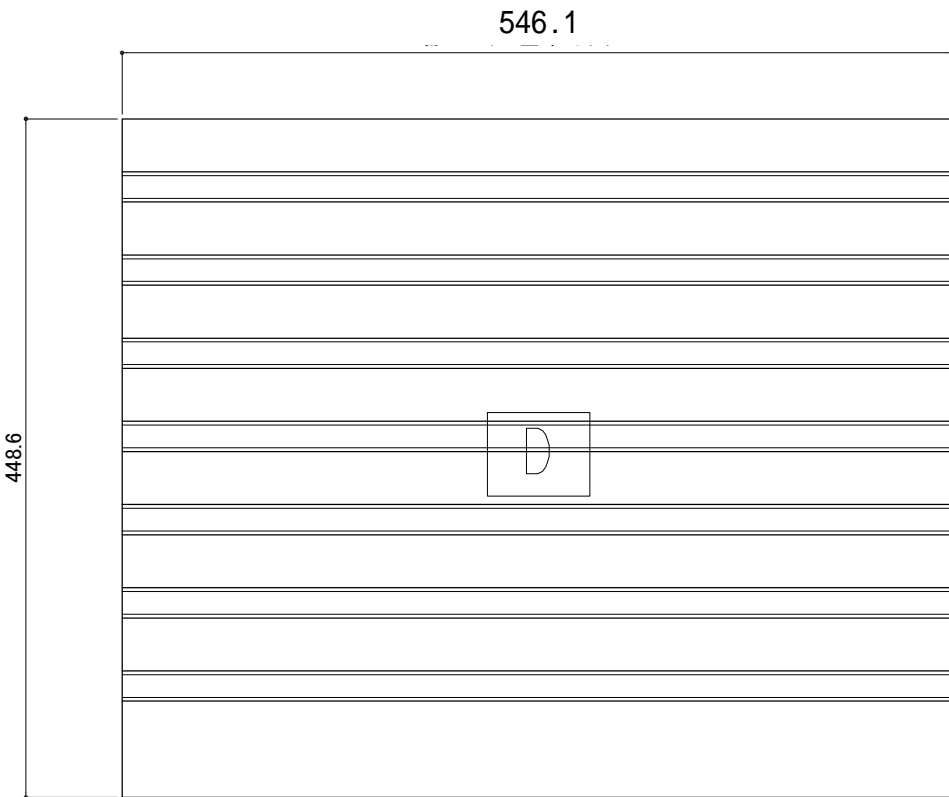
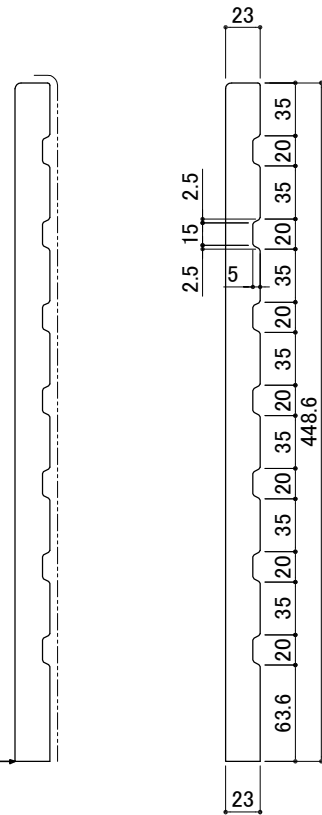

柱型テラコッタタイル

せっき質 施釉タイル

PC取付用裏面処理・シアコネクタ設置

※シアコネクタ取付位置別図参照

----- 施釉範囲

※仕上げ面施釉部はR1面取、裏面はR3面取

PC打込柱型テラコッタタイル形状図

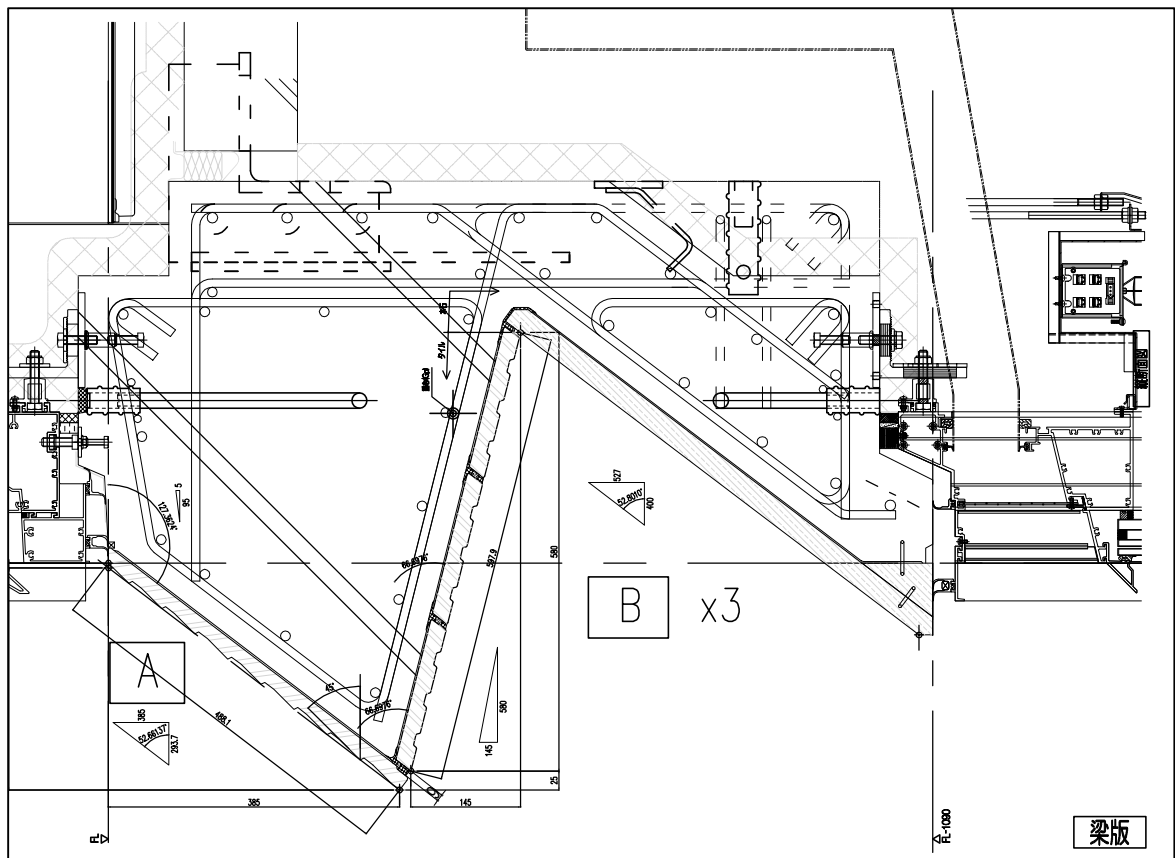

刃型テラコッタ 木主テラコッタ

せっき質 施釉タイル

PC取付用裏面処理・シアコネクタ設置

※シアコネクタ取付位置別図参照

----- 施釉範囲

※仕上げ面施釉部はR1面取、裏面はR3面取

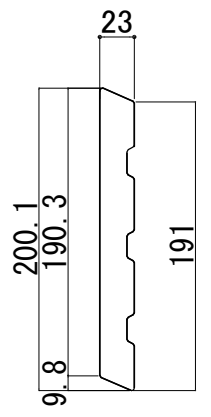
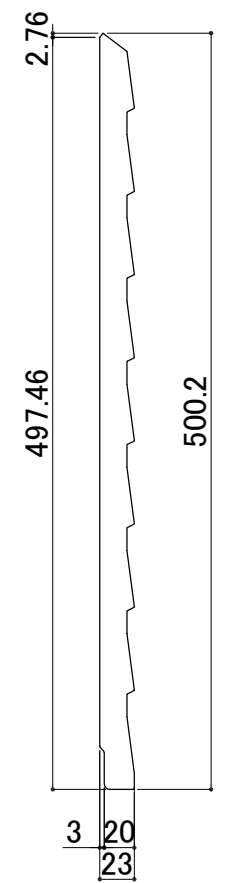

標準形状 586.3(端部:543.3)

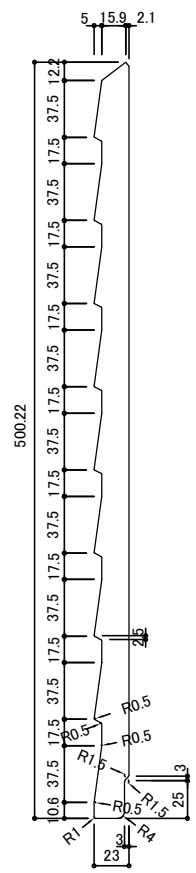
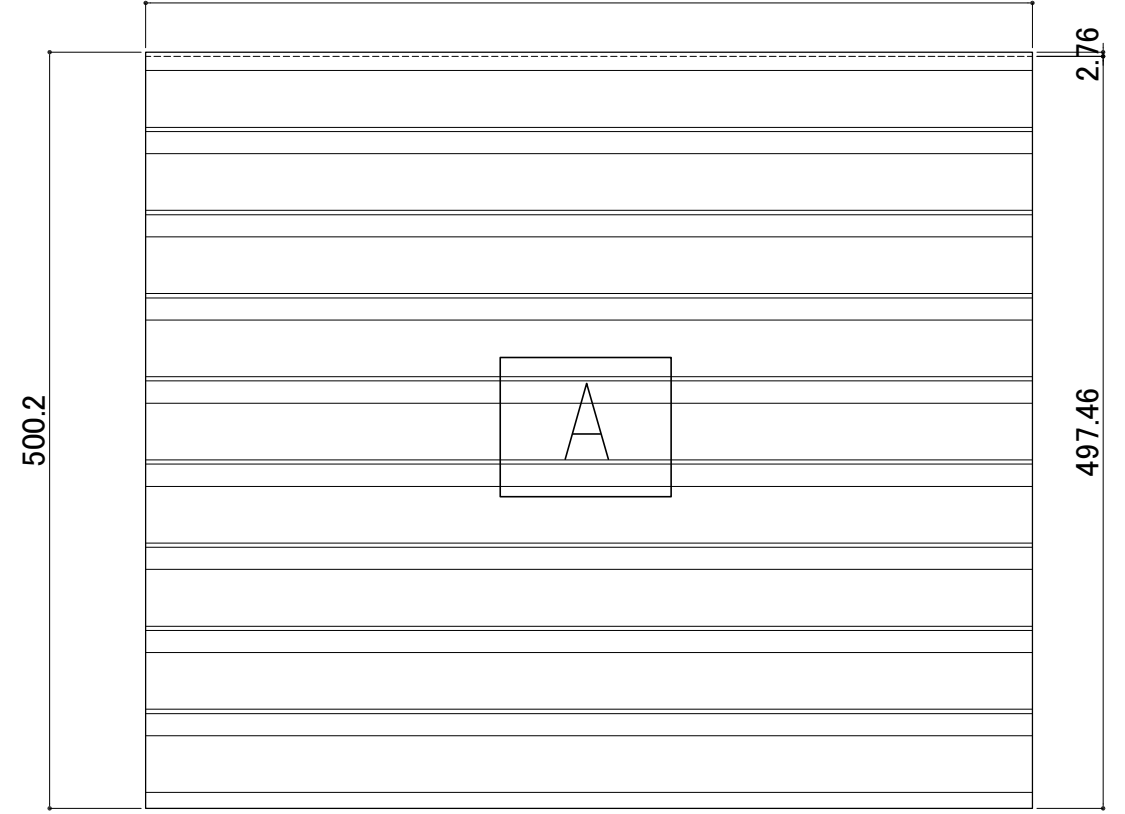

標準形状 586.3(端部:543.3)

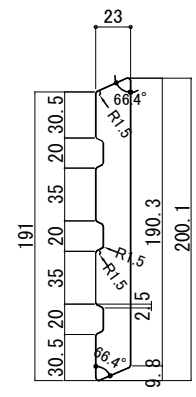
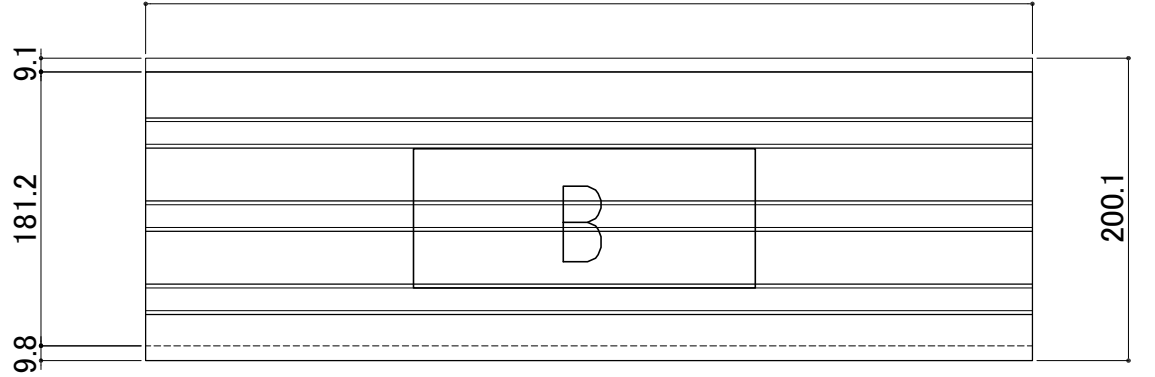

PC打込梁型テラコッタタイル形状図